



TAKE A LOOK AT THE BRIGHT FUTURE OF AERATION TECHNOLOGY

AERATION PERFORMANCE THROUGH INNOVATION

- ▶ COMPLETE AERATION SYSTEMS
- ▶ FINE & COARSE BUBBLE DIFFUSERS
- ▶ ADVANCED MEMBRANE SCIENCE
- ▶ CREEP & SHRINK RESISTANCE
- ▶ LONG LIFE AT HIGH EFFICIENCY
- ▶ REPLACEMENT PARTS & RETROFITS



DIFFUSED AERATION HAS CHANGED DRAMATICALLY IN THE LAST DECADE. YOU HAVE COME TO THE RIGHT PLACE TO LEARN ABOUT THIS MODERN TECHNOLOGY, AND HOW TO PUT IT TO WORK FOR YOU OR YOUR CLIENT. VAST IMPROVEMENTS HAVE BEEN MADE IN RELIABILITY, COST AND EFFICIENCY, AND MONITORING OF AERATION SYSTEMS, WHICH KEEP YOUR PLANT RUNNING 24/7, 365 DAYS A YEAR, IN PEAK OPERATING CONDITION.

INNOVATION RELIABILITY EXPERIENCE

HOW CAN WE HELP YOU?

WITH THOUSANDS OF
INSTALLATIONS IN OVER 70
COUNTRIES

PRODUCTION AND
INVENTORY ON 3
CONTINENTS IN 4 LOCATIONS

A TEAM OF EXPERIENCED
ENGINEERS, STAFF, AND A
NETWORK OF QUALIFIED REPS
IN ALL 50 STATES IN U.S AND
AROUND THE WORLD,

YOU CAN RELY ON SSI.



Reliability comes primarily from our special ability to encapsulate the black rubber membrane that you are probably already familiar with. Methods of encapsulation include PTFE® coating and gas fluorination. By sealing the membrane, we can significantly slow the natural aging process of a rubber membrane in both municipal and industrial wastewater.

SSI delivers the best Value for your money. A system that operates continuously at “like-new” conditions of oxygen transfer and back pressure, in a reliable way without mechanical failures, is probably your best value. Cost, on the other hand, is something that means different things to different clients (i.e. Contractors, OEM’s, and Consulting Engineers and their Clients). There are capital costs, installation costs, maintenance costs, and cost of energy to operate the system. The energy cost of an aeration system is as much as 70% of the total energy cost of a plant, and up to 18% of the entire energy consumption of a city!

Experience is a strong point of SSI. We have been owner-operated since inception 15 years ago, and we pride ourselves on employee retention.

Thus we have a very deep bench of experienced Engineers and Technicians, who have years of experience working in all kinds of environments and plants, and are used to dealing with everything from divers for wet install retrievable systems to in-situ monitoring and cleaning systems to advanced troubleshooting.

SSI diffuser technology is recognized around the world because it works. Most plants are content with a 5-7 year membrane life, but there is no need to be satisfied with that any longer. Membrane life far in excess of 10 years is now achievable, and at a good value. New technology continues to flow out of the SSI R & D lab, including a new method of making membranes that produce micro bubbles and resist fouling, as well as a new creep resistant polyurethane membrane. Our patented and patent pending PTFE coated membranes and fEPDM membranes have already revolutionized the industry.

You are in good Company with SSI. Wastewater treatment plants in the US at Dallas, Chicago, Fort Lauderdale, Tacoma and Phoenix as well as internationally in Jeddah, Moscow, and Seoul have adopted modern technology from SSI.

EPDM Manufactured by compression molding with a standard cure, low plasticizer content, and 1mm or 2mm perforations. Compression molding with modern equipment utilizing individual thermocouples and vacuum technology ensures a repeatable very high quality product,



PTFE Developed in 2004 and patented under US Patent Numbers 7396499 and 7674514, the PTFE-coated EPDM membrane is now proven technology. The PTFE surface layer protects the EPDM substrate from chemical attack, while at the same time significantly reducing surface fouling on the membrane. In time, we expect to learn that PTFE-coated EPDM membranes outlast standard EPDM, thereby reducing the life cycle costs even further. Industrially, this product is a "must have," and has become the industry standard in pulp and paper, dairy, refinery, carbonated beverage and landfill leachate applications. Municipally, it is used by major cities worldwide due to the anticipated life cycle cost benefits and reduced maintenance. Per independent testing by Akron Rubber Development Labs, both PTFE and fEPDM offer significant improvements over untreated EPDM in terms of having less plasticizer loss and less creep.



ANTI-STATIC EPDM This new patent pending membrane produces very fine bubble sizes by eliminating the polar attraction of the bubble to the membrane surface. It may also aid in fouling resistance over the long term.



SILICONE Silicone membranes offer high temperature resistance, and chemical resistance that differs from other products. Silicone is an inorganic, and therefore offers excellent resistance to many organic wastes. Our formulation is designed to resist tearing and creep, while producing fine bubbles at a modest headloss.



fEPDM Patent-pending fEPDM membranes were developed in 2007 as an answer to those few cases where solvents were present and posed a risk to PTFE-coated membranes. In practice, they have outstanding chemical resistance similar to Viton®. A significant additional benefit of fEPDM membranes is that the entire outer surface area of the membrane is protected. This proprietary process also treats and protects the inner slits! Per independent testing by Akron Rubber Development Labs, both PTFE and fEPDM offer significant improvements over untreated EPDM in terms of having less plasticizer loss and less creep.



VITON® This material has been used successfully by SSI in a few applications where cost is not an issue. The membrane works very well, and is highly resistant to most foulants and chemicals. However, it is quite costly. Viton® costs about 10 times what EPDM does.

Viton® is a registered trademark of DuPont



WEBBED URETHANE This new SSI development shifts stress from the Urethane material to a very strong fabric web that is imbedded in the membrane. This has the ability to reduce the level of creep or stretching that occurs in the membrane over time, as compared to an unreinforced Urethane. This product is available for discs, tubes and panels, and as a retrofit for other makes of diffuser.



WE MANUFACTURE OUR DISC DIFFUSERS WITH COMPRESSION MOLDED MEMBRANES. STANDARD MATERIALS ARE EPDM AND FLUOROELASTOMER LAYERED EPDM.

DISC DIFFUSERS

Compression molding ensures that we produce a part with even specific gravity and uniform tear resistance. Other molding techniques such as injection molding produce similar looking parts, but the tear resistance of a compression molded part is multidirectional, whereas the tear resistance of an injection molded part tends to be unidirectional just like wood which has a grain.



There is an art to using just the right amount of plasticizer in an EPDM membrane. Use too much, or the wrong type, and emulsifying fats can leech plasticizer and cause shrinkage and increase hardness. Use too little, and the rubber loses its memory, bubble size increases, and the membrane is at risk for flexure failure. SSI has a great deal of experience experimenting with different types and amounts of plasticizer, as well as other components of formulated EPDM rubber, such as fillers and curatives, and we put this experience to work.

SSI PODS™

The beauty of this Optional upgrade is that it comes pre-assembled



DIFFUSERS COME COMPLETELY ASSEMBLED

Install up to 20 diffusers/man hour – twice as fast as competitive diffused aeration systems because the diffusers arrive at your plant completely assembled and completely mounted. No diffuser parts and pieces to assemble, grease or hand tighten. *Just lift the headers straight from the truck to your tank!*

AFD270 9" DISC

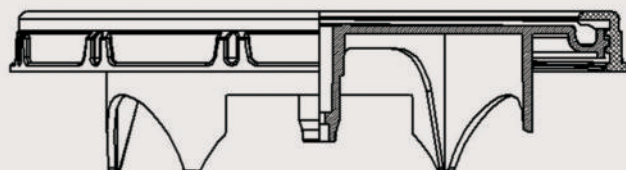
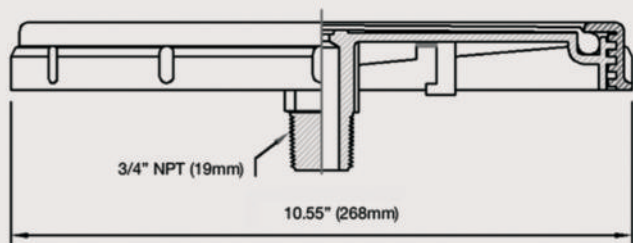

DESIGN FLOW: 1.5 - 3.0 SCFM (2.5 - 5.0 Sm³/hr)
 FLOW RANGE: 0 - 7 SCFM (0 - 12 Sm³/hr)
 ACTIVE SURFACE AREA: 0.41 ft² (0.0375 m²)
 SLIT QUANTITY: 6,600
 WEIGHT: 1.5Lbs. (680 g)

HIGHEST POSSIBLE QUALITY AND TECHNOLOGY MEANS YEARS OF TROUBLE-FREE EFFICIENT OPERATION.

- Industry Standard Size and Shape. Membranes are interchangeable with (3) other manufacturers.
- Experienced Engineering and Drafting staff with years of practice to assist you.
- Simple and quick installation with QC Saddle or Grommet.
- 212 F (100 C) temperature resistance and environmentally friendly polypropylene body.
- Compression-molded membranes with individual thermocouples in each cavity = 100% quality control
- Each membrane checked for even perforation depth to ensure uniform air release.

HEADLOSS

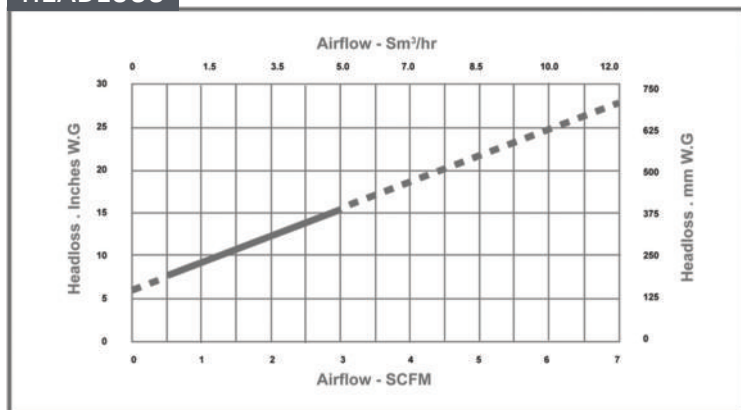

HIGHEST POSSIBLE SOTE INDEPENDENTLY TESTED PER ASCE, AND LOWEST POSSIBLE HEADLOSS.

- Low membrane plasticizer content to reduce shrinkage and hardening, but enough to avoid creep.
- Multiple integral check valves keep your aeration piping system clean.
- 21st century special materials such as PTFE and fEPDM for outstanding chemical fouling resistance, or for the highest oxygen transfer efficiency at an acceptable headloss.

SOTE

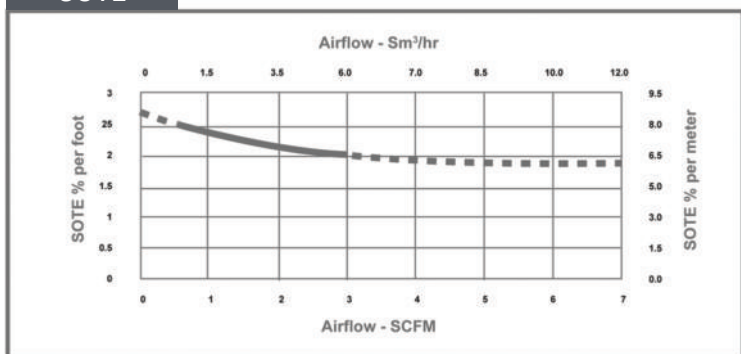

IN STOCK ON 3 CONTINENTS IN 4 LOCATIONS

AFD350 12" DISC

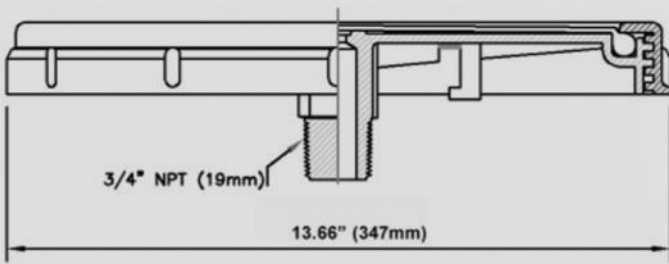

DESIGN FLOW: 2.5 - 5.0 SCFM (4.2 - 8.3 Sm³/hr)
 FLOW RANGE: 0 - 12 SCFM (0 - 20 Sm³/hr)
 ACTIVE SURFACE AREA: 0.700 ft² (0.065 m²)
 SLIT QUANTITY: 10,155
 WEIGHT: 3.0Lbs. (1.4 Kg)

HIGHEST POSSIBLE QUALITY AND TECHNOLOGY MEANS YEARS OF TROUBLE-FREE EFFICIENT OPERATION.

HEADLOSS

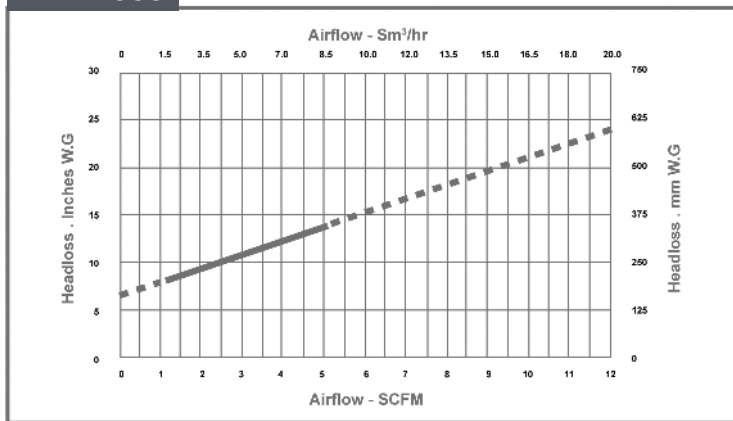

- More economical but as efficient as a 9" (270mm) disc diffuser. AFD350 has an even lower headloss than AFD270, often resulting in the highest SAE (kgO₂/kWh) when compared to other fine bubble diffusers.
- Experienced Engineering and Drafting staff with years of practice to assist you.
- Simple and quick installation with QC Saddle or Grommet.
- 212 F (100 C) temperature resistance and environmentally friendly polypropylene body.
- Compression-molded membranes with individual thermocouples in each cavity = 100% quality control
- Each membrane checked for even perforation depth to ensure uniform air release.
- Low membrane plasticizer content to reduce shrinkage and hardening, but enough to avoid creep.
- Multiple integral check valves keep your aeration piping system clean.
- 21st century special materials such as PTFE and fEPDM for outstanding chemical or fouling resistance, or for the highest oxygen transfer efficiency at an acceptable headloss.

HIGHEST POSSIBLE SOTE INDEPENDENTLY TESTED PER ASCE, AND LOWEST POSSIBLE HEADLOSS.

SOTE

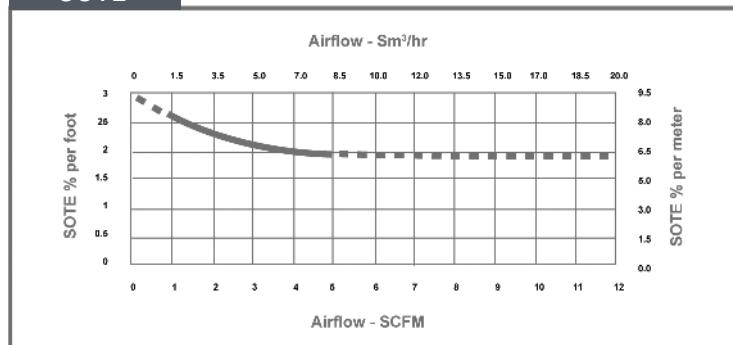

IN STOCK ON 3 CONTINENTS IN 4 LOCATIONS

“We installed over a thousand SSI 9" fine bubble disk diffusers in 1997 and are still operating with the original membranes. Since installing the diffusers, the plant has met its effluent requirements and we are thoroughly satisfied with the aeration system applied by SSI.”

Jason Tincu, Wastewater Supervisor, City of Xenia





TUBE DIFFUSERS

TUBE MEMBRANES

WEBBED
URETHANE

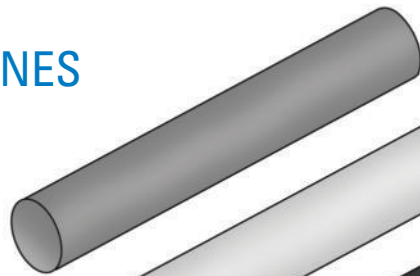

PTFE DISPERSION

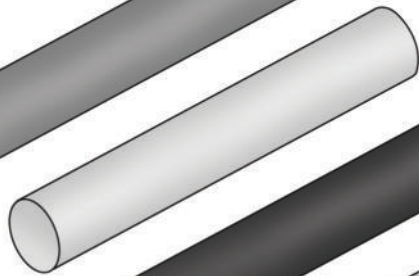

EPDM

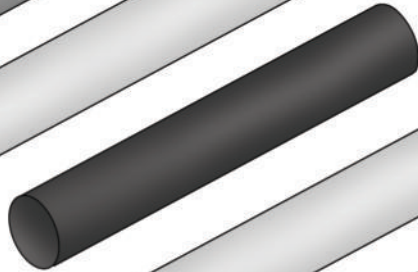

SILICONE

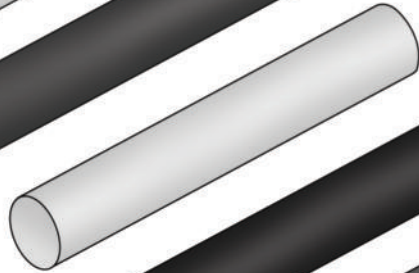

ANTI-STATIC EPDM

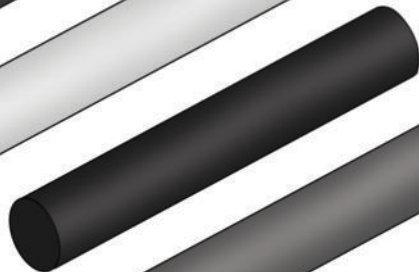

fEPDM

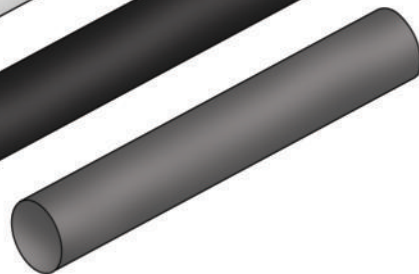

21st century special materials, such as PTFE-coated surface layers, fEPDM, anti-static EPDM, webbed urethane, as well as reinforced and coated ultra fine bubble membranes, offer outstanding chemical and fouling resistance, in addition to the highest oxygen transfer efficiency at a headloss you can live with.

AFTS2100 62mm Tube

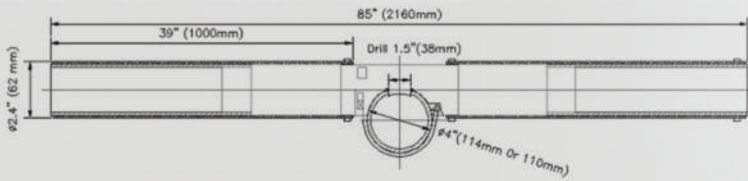

DESIGN FLOW: 1.5 - 8.5 SCFM (2.6 - 14.5 Sm³/hr)
 FLOW RANGE: 0 - 10.0 SCFM (0 - 17 Sm³/hr)
 ACTIVE SURFACE AREA: 3.25 ft²/set (0.300 m²)
 WEIGHT: 7.0Lbs./set (3.2 Kg)

HIGHEST POSSIBLE QUALITY AND TECHNOLOGY MEANS YEARS OF TROUBLE-FREE EFFICIENT OPERATION.

- Industry Standard Size and Shape. Membranes are interchangeable with other manufacturers.
- Experienced Engineering and Drafting staff with years of practice to assist you.
- Simple and quick installation with Snappy Saddle™ Mount, which can be done by one person.
- 212 F (100 C) temperature resistance and environmentally friendly high temperature ABS body.
- Compression-molded membranes with individual thermocouples in each cavity = 100% quality control
- Each membrane checked for even perforation depth to ensure uniform air release.
- Low membrane plasticizer content to reduce shrinkage and hardening, but enough to avoid creep.
- Multiple integral check valves keep your aeration piping system clean.
- 21st century special materials such as PTFE and fEPDM for outstanding chemical of fouling resistance, or for the highest oxygen transfer efficiency at an acceptable headloss.

HEADLOSS PER METER

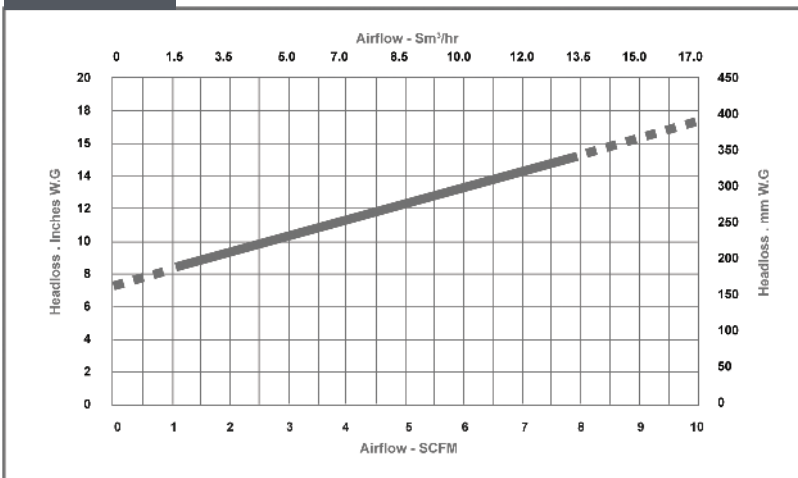

HIGHEST POSSIBLE SOTE INDEPENDENTLY TESTED PER ASCE, AND LOWEST POSSIBLE HEADLOSS.

SOTE PER METER

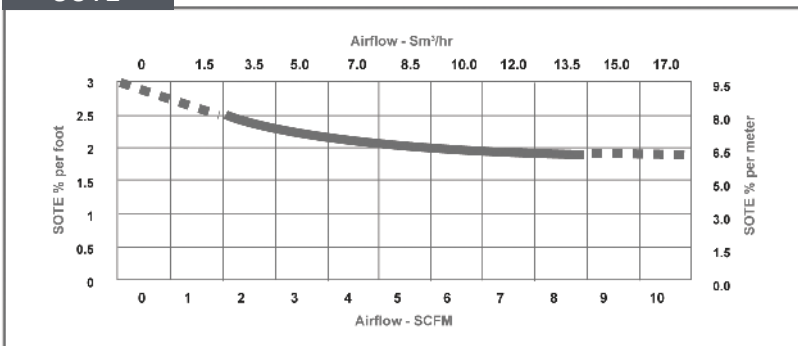

IN STOCK ON 3 CONTINENTS IN 4 LOCATIONS

AFTS3100 91mm Tube

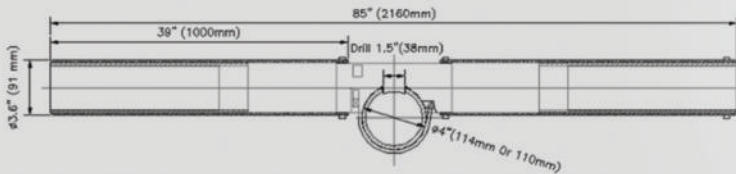

DESIGN FLOW: 2.0 - 13 SCFM (3.4 - 22 Sm³/hr)
 FLOW RANGE: 0 - 15 SCFM (0 - 26 Sm³/hr)
 ACTIVE SURFACE AREA: 4.75 ft²/set (0.440 m²)
 WEIGHT: 10 Lbs./set (4.50 Kg)

HIGHEST POSSIBLE QUALITY AND TECHNOLOGY MEANS YEARS OF TROUBLE-FREE EFFICIENT OPERATION.

- Industry Standard Size and Shape. Membranes are interchangeable with other manufacturers.
- Experienced Engineering and Drafting staff with years of practice to assist you.
- Simple and quick installation with Snappy Saddle™ Mount, which can be done by one person.
- 212 F (100 C) temperature resistance and environmentally friendly high temperature ABS body.
- Compression-molded membranes with individual thermocouples in each cavity = 100% quality control
- Each membrane checked for even perforation depth to ensure uniform air release.
- Low membrane plasticizer content to reduce shrinkage and hardening, but enough to avoid creep.
- Multiple integral check valves keep your aeration piping system clean.
- 21st century special materials such as PTFE and fEPDM for outstanding chemical fouling resistance, or for the highest oxygen transfer efficiency at an acceptable headloss.

HEADLOSS PER METER

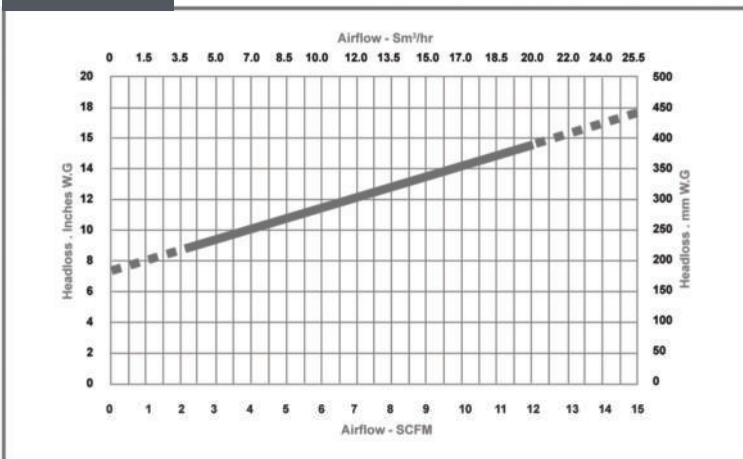

HIGHEST POSSIBLE SOTE INDEPENDENTLY TESTED PER ASCE, AND LOWEST POSSIBLE HEADLOSS.

SOTE PER METER

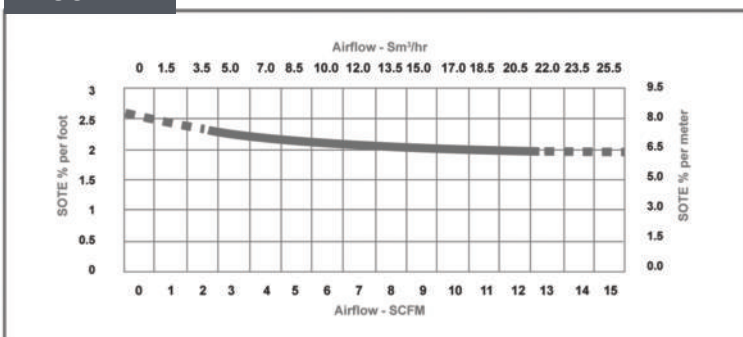

IN STOCK ON 3 CONTINENTS IN 4 LOCATIONS

“We came across the SSI PTFE diffusers and first tried them in the summer of 2005. It was probably the best decision we have made in our wastewater treatment plant since it started processing water. Not only can we afford to replace the old diffusers, the new SSI diffusers seem to be more durable than the old ones and don't require as much maintenance. We also see that they do not plug up or scale up as bad as the old diffusers. Our current blowers could not be happier as well as myself. We have been thoroughly satisfied with the SSI diffusers.”

Paul Johnson, Environmental Manager, SCA Tissue®



MOISTURE PURGE SYSTEM

An airlift type purge system is used in all SSI fine bubble aeration systems to remove condensate from the piping system. Purging entrained water helps ensure even air distribution to all diffusers in a grid. A ball valve is supplied with the system and is opened manually. Continuous purge systems are available for retrievable-type aeration systems, or where it is not possible to fasten a purge line to a tank wall.

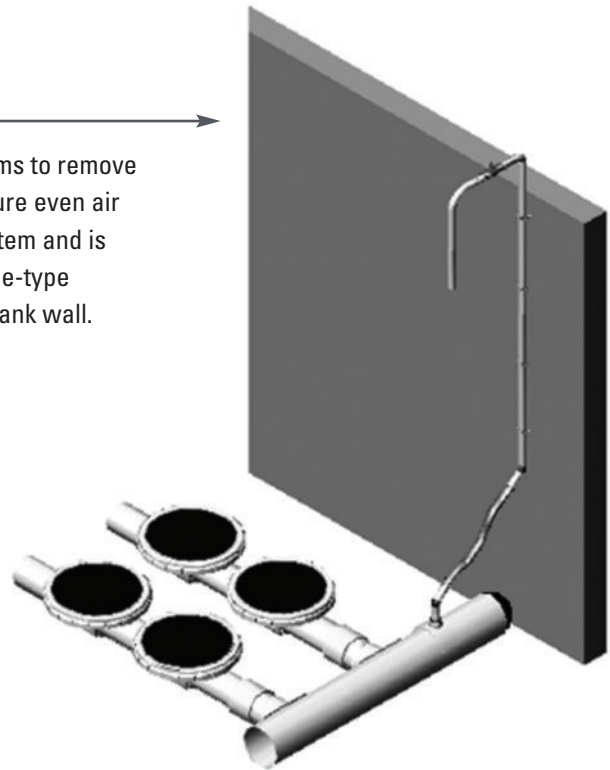
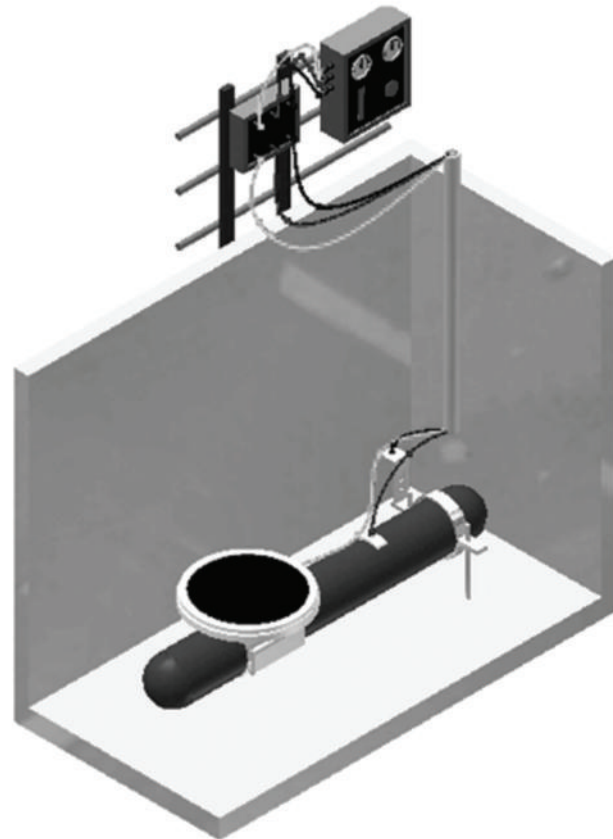

PRESSURE MONITORING SYSTEM

Throughout the life of an aeration system, oxygen transfer efficiency may decline somewhat when diffusers become fouled, but headloss can increase significantly, which can significantly increase energy costs. A pressure monitoring system enables the operator to better determine the optimal cleaning frequency of the membranes. The fouling rate can vary by aeration zone, hence it is recommended to install at least one system in each zone.

ACID DOSING SYSTEM

In some cases where wastewater is aggressive, an in-situ acid dosing system may be helpful in controlling calcium scale inside membrane slits. A variety of acids, including acetic acid, muriatic acid or formic acid can be used. The small volume of acid used to clean membrane slits will not affect the process. This system should be used in conjunction with an SSI Pressure Monitoring System, to determine when cleaning is required, and to confirm after cleaning that the desired results have been achieved.

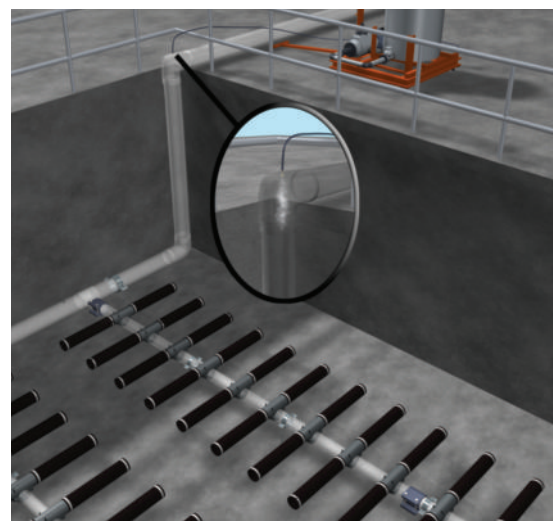

SUPPORT STANDS

Support Stands are available in 304 SS, 316 SS or in ABS plastic. SSI's standard is 304 SS with drop-in anchor bolts. In our aeration piping systems, support stands fulfill the dual role of anchoring pipes to the floor and controlling thermal expansion and contraction. ABS support stands are primarily used with disc diffusers and plastic pipe, where a low capital cost is the primary objective.

Contact factory for more details about how and where to place guide and fixed stands.



Standard



Serpentine

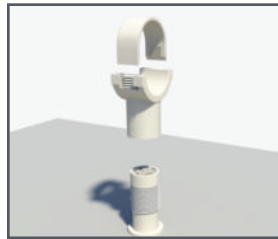

Plastic

EXPANSION JOINT OPTIONS

Positive locking bolted stainless steel couplings are suitable for drop pipes, stainless joints, and for all tube diffuser piping systems to restrict header pipe rotation.



Expansion Joints are available in a positive locking design or in flexible PVC with a stainless steel shell. SSI recommends the flexible expansion joints for disc installations and the positive locking type for tube diffuser projects

Slotted band joints with stainless steel shear rings are suitable for disc fine bubble and cap coarse bubble lateral plastic piping systems, in conjunction with SSI's fixed and guide support stand system to manage thermal expansion and contraction.

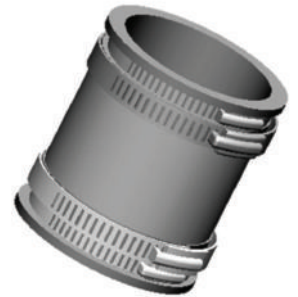

SSI's heavy duty expansion joint provides a double O-ring to prevent rotation, and allows limited longitudinal travel to absorb plastic pipe expansion and contraction.

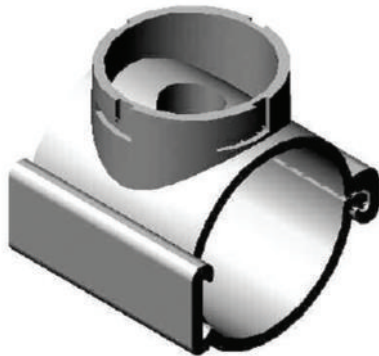
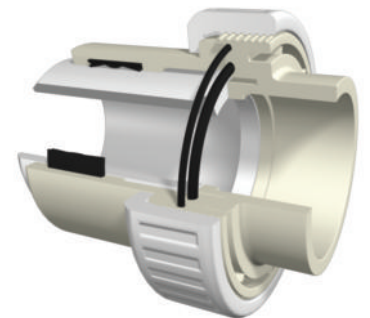

SADDLES

Patented Quick Connect Saddles mount on nominal US 4" or metric 110mm OD pipe. They allow retrofit of 12" to 9" discs without changing the piping system.

Quick Connect Saddles are made of polypropylene, and install into a 1-3/4" (44.5mm) hole.

We are adding a US 3" sizes or metric 90mm

GROMMETS

Grommets are available for round plastic or square stainless steel pipes in US or Metric dimensions. Installation is simple.

Multiple sizes are available on pipe wall thickness. Grommets install into a 1-1/4" (32mm) chamfered hole.



REPLACEMENT DIFFUSER MEMBRANES

SSI makes replacement diffuser membranes and some parts for most brands. Available materials include EPDM, PTFE dispersion, fEPDM, Silicone, and Webbed Urethane.

These include the following brands:

Aercor™, Aqua Aerobic™, EDI™, Envicon™, Flexazur™, Gummi Jaeger™, ITT Sanitaire™, Nopon™, Ott™, Parkson™, Schreiber™, Siemens/US Filter/Envirex™, and Supratec™

SSI™ RETRIEVABLE SYSTEMS

SYSTEMS
SYSTEMS
SYSTEMS

If you need to install an aeration system without dewatering the basin, or you have a single aeration basin, or aggressive wastewater that requires more frequent observation of diffusers, then a retrievable aeration system could be the answer.

SSI has significant experience manufacturing retrievable aeration systems for both wet and dry installation, utilizing flexible hose or rigid stainless steel drop pipes. Systems can be made crane or winch liftable, and can be manufactured with either tube or disc diffusers, and can be made without guide rails, or with single or dual guide rails. Air may be fed either from the side of the basins, or from floating pipes on the surface.

The wire to water efficiency of a retrievable fine bubble grid, when properly designed, is similar that of a fixed grid system. Since this efficiency can be as much as two times the efficiency of mechanical aeration, retrievable systems are often considered for supplemental aeration in oxidation ditches and lagoons, where the existing mechanical aerators cannot supply enough oxygen.



Retrievable grid with SSI Snappy Saddle™ Diffusers and a 304 SS frame replacing an underperforming floating lateral system



Disc diffusers provide exceptionally high oxygen transfer efficiency in this aeration tank in Spain.



These liftable fine bubble tube grids on guide rails have worked over 10 years in this municipal WWTP

STAINLESS STEEL COARSE BAND

Design Flow: 10-40 SCFM (17-67 SM³/hr)
 Flow Range: 0-40 SCFM (0-67 SM³/hr)
 Hole Quantity: 44 Holes
 Length: 24" (600mm)



Our Stainless Steel WBCB diffusers are available in 304L or 316L stainless steel. The diffuser is made with cast endcaps welded all around. A typical piping system utilizing SSI WBCB diffusers is made from Stainless Steel pipe with 3/4" FNPT gusseted tees or elbows welded to the bottom center line.

Deflectors are supplied with each diffuser but can be removed. The coarse bubble diffuser is intended to be a clog-free design, with oxygen transfer rates of 0.5 to 0.8% per foot of submergence (1.7 to 2.5% SOTE/m).

They have a reliable alpha value and are designed to economically cover the tank floor. The diffuser is most often applied for mixing aerobic digesters, channels, equalization tanks and grit chambers.

Airflow in SCFM	Airflow in m ³ /hr.	Orifice Size in inches	Headloss in inches WC	Headloss in mm WC
5	8.5	5/16"	10" WC	254 mm WC
10	17	7/16"	10" WC	254 mm WC
15	25.5	9/16"	10" WC	254 mm WC
20	34	11/16"	10" WC	254 mm WC
25	42.5	3/4"	10" WC	254 mm WC
30	51	3/4"	14" WC	355.6 mm WC
35	59.5	3/4"	19" WC	482.6 mm WC
40	68	3/4"	25" WC	635 mm WC

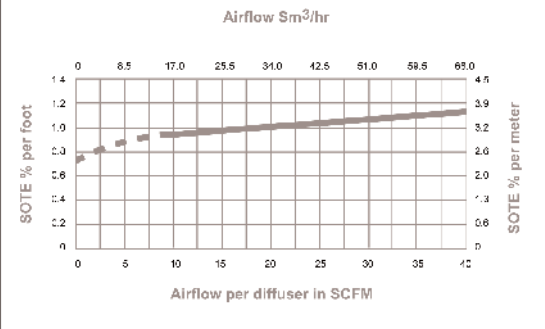

CAP AFC75

Design Flow: 3-6 SCFM (5 -10 SM³ /hr)
 Flow Range: 0-10 SCFM (0-17 SM³ /hr)
 Hole Quantity: 10 x 5mm holes



Caps are most commonly used in aerobic digesters and equalization tanks where high rate oxygen transfer efficiency is not required. They are manufactured from black Acrylic plastic containing UV protection and membranes are made from the same EPDM compound that SSI uses in fine bubble diffusers. SSI's Cap diffuser is a non-clog design operated well under both intermittent and continuous conditions. A typical piping system using SSI AFC75 diffusers is made from PVC, CPVC or Stainless Steel pipe, with Grommets, Drilled and Tapped pipe, or welded 3/4" FNPT SS bosses to the top center line.

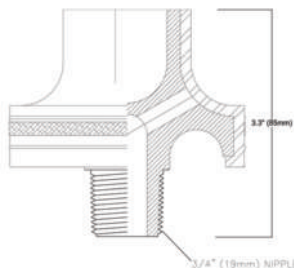
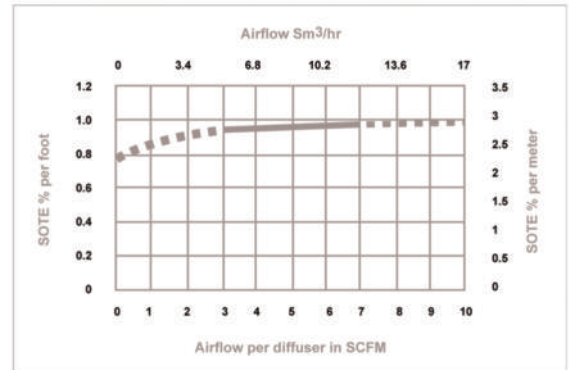
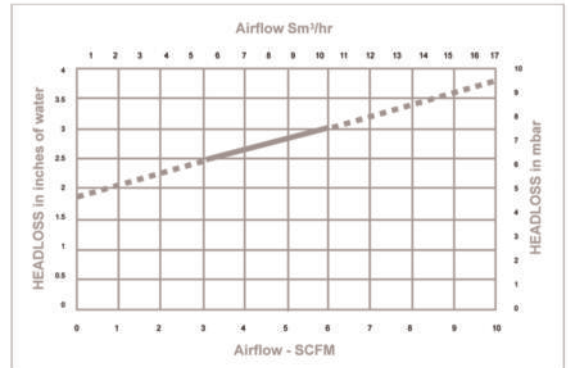

RELIA-BILL™

Relia-bill SOTE ranges from 0.8 to 1.0 %/ft (2.5 to 3.2%/m)
 Airflow SCFM (m³/hr)
 Headloss in "WG (mbar)

The Relia-bill™ coarse bubble diffuser is a modern clog-free coarse bubble diffuser. It will not clog due to rags or sludge, and is ideally suited to aerobic digesters, equalization basins and anoxic zones.



SSI aeration products are covered under
 US Patents 7,674,514
 7,398,499
 6,811,148
 and multiple international patents
 and patents pending.



SSI AERATION, INC.

4 TUCKER DRIVE | POUGHKEEPSIE, NY 12603 | U.S.A

TEL: +1 845 454 8171

FAX: 845-454-8084

WEBSITE: STAMFORDSCIENTIFIC.COM

E-MAIL: INFO@STAMFORDSCIENTIFIC.COM

SSI WARRANTY

SSI aeration products and systems are warranted to be free from defects in manufacture or workmanship for 12 months from the date of installation, up to 18 months after the date of shipment. Parts found to be defective in materials or workmanship will be repaired or replaced without charge, with freight to be at our option. The responsibility of SSI is limited to the cost of defective parts. Damage caused to SSI aeration products by chemicals, wear caused by the presence of abrasive, sticky or oily materials, poor maintenance, installation or operation not in accordance with our manual shall not constitute defects. SSI is able to stand behind our pledge of quality because we continually test all our equipment ensuring greater quality control. Our test results are made available upon request.

Extended warranties are available for encapsulated membranes (PTFE and fEPDM). Consult factory for details.

SSI maintains various production and support facilities worldwide:
USA (New York – Headquarters, Manufacturing, Engineering, Warehousing and Service)
Europe (Holland – Warehouse and UK – Sales, Service and Manufacturing)
Asia (Korea – Manufacturing, Engineering, Warehousing and Service and India – Engineering Sales and Service)
Middle East (UAE - Warehousing, Sales and Service)

READ TESTIMONIALS

In 2006 we took our first group of three tanks off line and installed 3000 of your 12-inch PTFE disc diffusers model AFD 350. As of Friday, Oct. 16, 2009, we started up our third project of three tanks and now have 9000 12-inch PTFE diffusers in operation.

*Robert C. Bauer, P.E.
 Fox Metro Water Reclamation District*

Regarding 45,000 SSI diffusers that installed at Makkah south WWTP. Wishing to inform you that those diffusers are working efficiently and we have not found any problem.

*Engineer Basim Malki,
 WWTP Projects Management Manager, JCBU*

The City of Alma wastewater plant has been operating SSI's PTFE coated 12" disc diffusers for almost one year with no problems. We have not had to perform any maintenance on the diffusers and there has been no instances of membrane clogging whatsoever. The PTFE coated diffuser membranes have made all the difference in our aeration basin since installation and we are very satisfied with SSI's product and would recommend to anyone.

*Max Kraus
 City Superintendent - City of Alma, Kansas*

It was determined that the 12" SSI diffusers provided the performance we desired plus the lowest, long-term, life cycle ownership costs of any diffuser investigated. Approximately 2050 diffusers were installed in one of four aerated reactors...the second and most heavily loaded reactor in the treatment train of this BNR-capable facility. The aeration capacity plus the designed aeration flexibility will be greatly enhanced by use of the SSI diffusers.

*Cal Tininiko,
 Chief Scientist, BacTee Systems*